

WIDE VIEW FULL FREE 3-STAGE MAST

Mast model	Max. lifting height (mm)	Load capacity (load center 600mm)(kg)		Mast overall height (mm)		Service weight(kg)		Fork tilt angle (front/rear)α/β
		CQD16-GB2SLi	CQD20-GB2SLi	1.6-2t	1.6-2t	CQD16-GB2SLi	CQD20-GB2SLi	
ZSM460	4600	1600	2000	2314	1280	3395	3650	2°/4°
ZSM480	4800	1600	2000	2381	1340	3410	3670	2°/4°
ZSM540	5400	1600	2000	2581	1540	3454	3730	2°/4°
ZSM570	5700	1600	1900	2681	1640	3476	3755	2°/4°
ZSM630	6300	1500	1900	2881	1840	3521	3815	2°/4°
ZSM675	6750	1450	1800	2982	1940	3576	3850	2°/4°
ZSM700	7000	1400	1700	3065	2030	3595	3870	2°/4°
ZSM715	7150	1400	1700	3115	2080	3606	3885	2°/4°
ZSM750	7500	1300	1700	3232	2190	3633	3920	2°/4°
ZSM800	8000	1200	1600	3398	2360	3669	3970	2°/4°
ZSM850	8500	1100	1400	3564	2530	3706	4015	2°/4°
ZSM900	9000	900	1100	3730	2690	3742	4065	2°/4°
ZSM950	9500	800	1000	3898	2860	3780	4110	2°/4°
ZSM1000	10000	-	850	4064	3030	-	4160	2°/4°
ZSM1050	10500	-	800	4230	3190	-	4205	2°/4°
ZSM1080	10800	-	750	4398	3290	-	4235	2°/4°
ZSM1100	11000	-	700	4564	3360	-	4255	2°/4°
ZSM1150	11500	-	650	4730	3530	-	4305	2°/4°
ZSM1200	12000	-	550	4898	3690	-	4350	2°/4°
ZSM1250	12500	-	500	4898	3860	-	4400	2°/4°

Note:The free lift height is 4600mm-6300mm when the truck is not assembled with backrest. The free lift height is 175mm increased and other height is 25mm increased.

WIDE VIEW MAST

Mast model	Max. lifting height (mm)	Load capacity(load center 600mm)(kg)		Mast overall height (mm)	Service weight(kg)		Fork tilt angle (front/rear)α/β
		CQD16-GB2SLi	CQD20-GB2SLi		1.6-2t	CQD16-GB2SLi	
M290	2900	1600	2000	2200	3235	3425	2°/4°
M320	3200	1600	2000	2350	3250	3440	2°/4°
M360	3600	1600	2000	2550	3280	3470	2°/4°
M380	3800	1600	2000	2650	3295	3485	2°/4°
M400	4000	1600	2000	2750	3310	3500	2°/4°
M420	4200	1600	2000	2850	3325	3515	2°/4°
M440	4400	1600	2000	2950	3335	3525	2°/4°
M460	4600	1600	2000	3050	3390	3580	2°/4°
M500	5000	1500	1900	3250	3420	3610	2°/4°

As: Right angle stacking aisle width
a: Clearance a=200mm

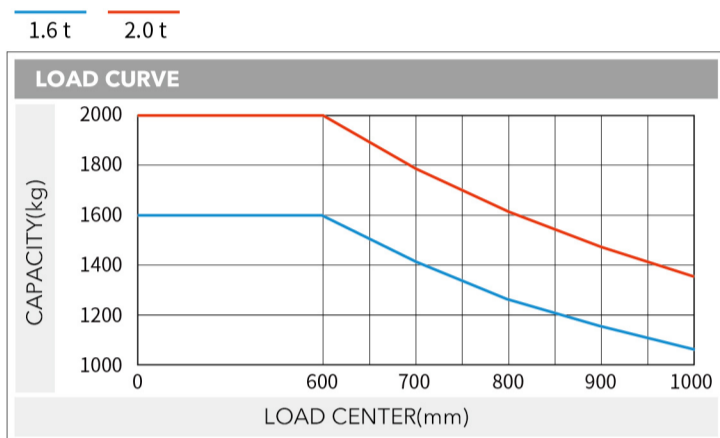
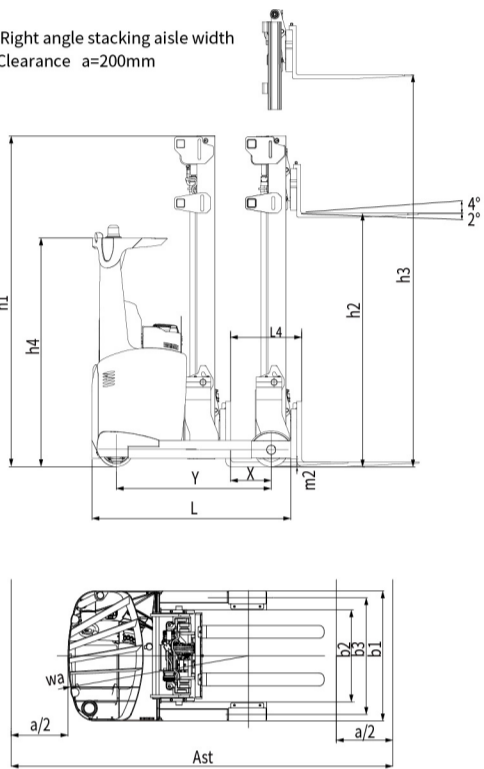

Note: The vertical axis stands for load capacity and the horizontal axis stands for load center which is calculated from the front surface of the forks to the gravity of the standard load. The standard load means a cubic with 1000mm edge length. When mast is tilted forward, using non-standard forks or loading large goods, the load capacity will be reduced. The load capacity of standard mast at different load center can be known from this load chart.

制造商和技术参数

Character		HELI	
1.01	Manufacturer		
1.02	Model	CQD16	CQD20
1.03	Configuration number	GB2SLi	GB2SLi
1.04	Load capacity	1600	2000
1.05	load center distance	C	600
1.06	Power mode	Lithium Battery	Lithium Battery
1.07	Driving mode	Seated	Seated
1.08	Wheel base	Y	1450
Tyre			
2.01	Tyre type	Polyurethane	Polyurethane
2.02	Number of wheels, driving wheel/bearing wheel (x-driving wheel)	1x/2	1x/2
2.03	Track width (bearing wheels)	b3	1157
2.04	Size of bearing wheel		φ285x100
2.05	Size of driving wheel		φ343x114
Size			
3.01	Lifting height of standard mast	h3	4600
3.02	Free lift	h2	1280
3.03	Mast height, lowered	h1	2314
3.04	Fork size:thickness × width × length	s/e/l	40x122x1150
3.05	Fork adjusting width		244-724
3.06	Fork tilt angle (front/rear)		2°/4°
3.07	Fork sideshifting		±75
3.08	Truck body length (fork excluded)	L	1840
3.09	Truck body width	b1	1270
3.10	Distance between support arms	b2	900
3.11	Reach distance	l4	606
3.12	Height of overhead guard (cab)	h4	2215
3.13	Ground clearance, below mast	m2	75
3.14	Turning radius	Wa	1689
3.15	Load distance, centre of support arm wheel to face of forks	x	369
3.16	Aisle width with pallet 1200 x 1200 across forks	Ast	2914
3.17	Aisle width with pallet 1000 x 1200 across forks	Ast	2777
Performance			
4.01	Travelling speed: with/without load		14/14
4.02	Lifting speed: with/without load		0.4/0.6
4.03	Lowering speed: with/without load		0.5/0.5
4.04	Reach speed, with/without load		0.11/0.11
4.05	Maximum climbing ability, with/without load		10/15
Weight			
5.01	Total weight (with battery)	kg	3460
5.02	Axle load, fork outreached, without load, front/rear	kg	1570/1880
5.03	Axle load, fork retracted, without load, front/rear	kg	2165/1270
5.04	Axle load, fork outreached, with load, front/rear	kg	610/4445
5.05	Axle load, fork retracted, with load, front/rear	kg	1920/3140
Battery			
6.01	Battery voltage/capacity	V/Ah	80/202(Standard) 80/272(Optional)
6.02	Battery weight	kg	430
6.03	Battery box dimension	mm	1220x298x790
Motor and controller			
7.01	Drive motor power (S2-60min)		7
7.02	Lifting motor power (S3-15%)		12.5
7.03	Steering motor power (S3-50%)		0.4
7.04	Transmission box		HELI special transmission box
7.05	Service brake		Electromagnetic brake
7.06	Hydraulic system working pressure		17.5

NOTE: *Detailed information about battery, please contact our salesman or engineer.

HELI

Reliable special designed instrument

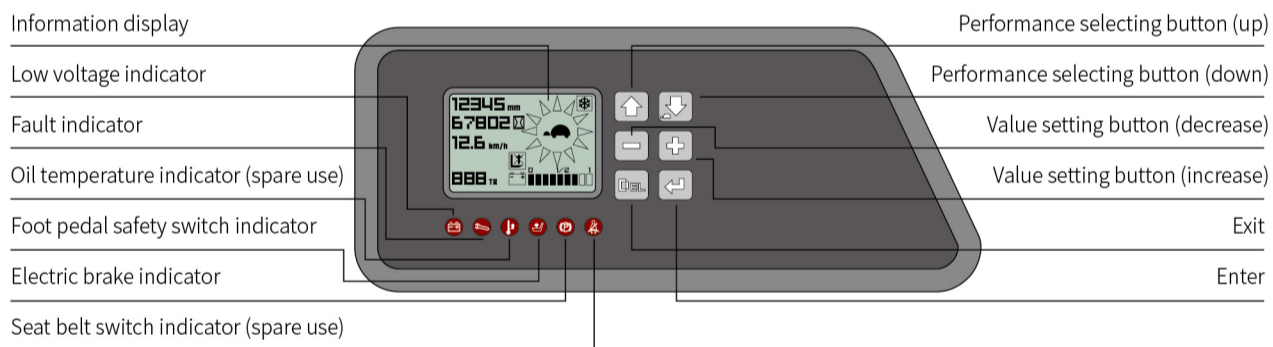

The reliable special instrument gives a complete display of the vital information, like operation status, fault detection, etc. It ensures the operator predominate the vehicle status more intuitive and convenient.

HELI smart fleet management system (optional)

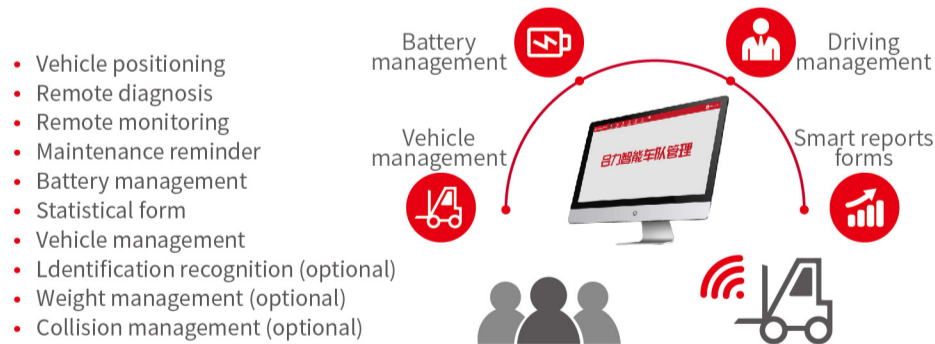

Charger technology



- High Efficiency**
Charging efficiency higher than 95% meeting the requirements of energy saving and emissions reduction.
- Speediness**
100% charging realized in 2 hours at the soonest.
- Compatibility**
48V/80V compatibility meeting the demand of different voltage levels.
- Safety**
Built-in mis-connecting protection offering self isolating function under fault; Perfect fault self checking alarm facilitating users maintenance.

Standard configuration

Optional device

- | | |
|--------------------------------------|------------------------------------|
| AC travelling motor | Three-stage full free lift mast |
| AC lifting motor | Fork with other length |
| AC steering motor | Fork extension |
| ZAPI travelling motor controller | Lifting height pre-selector |
| ZAPI lifting motor controller | Monitoring system |
| ZAPI steering motor controller | Battery charger |
| Electromagnetic brake | Customer made color |
| DC/DC converter | Battery side pulling |
| Low noisy gear pump | HELI smart fleet management system |
| Control valve (four throw) | |
| Integral sideshifter | |
| Standard fork | |
| Backrest | |
| Polyurethane tyre | |
| LED meter | |
| Front working light | |
| Warning light | |
| Safety belt | |
| Rearview mirror with wide view angle | |
| Blue warning light | |

www.heliforklift.net

HELI

1.6-2.0 t
G2 SERIES LITHIUM BATTERY
POWERED REACH TRUCK
(SIT-DOWN TYPE)(80V)



ANHUI HELI CO., LTD.

Add / No.668, FangXing Road, Hefei, China
Fax / +86-551-63639966
Tel / +86-551-63639068(America); 63639258(Europe); 63639358(Asia);
63662105(Africa & Middle East); 63639530(Overseas Marketing)



LinkedIn



YouTube



Facebook

G2 1.6-2.0 t

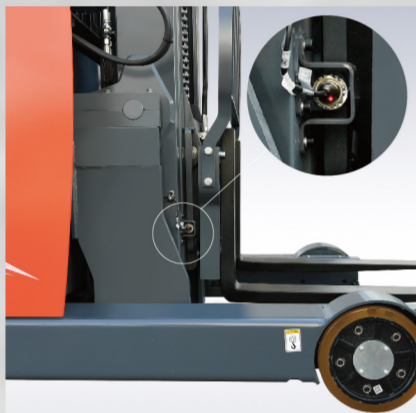

Intelligent security protection

- Intelligent stabilization system : it can automatically adjust the mast and the truck speed according to the lifting height and load state . Improve the high bearing capacity and vehicle stacking safety ;
- Intelligent speed limit in different application : multi-scenario identification and intelligent speed limit balance efficiency and safety ;
- Intelligent limit buffering : intelligent induction of mast lifting and lowering avoids extreme impact and is safe and comfortable ;
- Intelligent operation protection : a full set of OPS system can avoid misoperation and ensure safety ;
- Intelligent control strategy : dual core controller is in line with the latest EU safety requirements ;
- Intelligent steering deceleration : the automatic deceleration function of the turning can reduce the risk of turning over ;

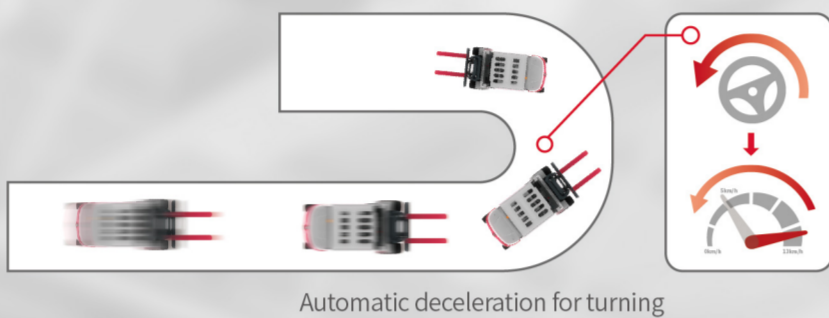

New designed hydraulic system

- New designed hydraulic system with high working efficiency
- High power lifting motor
- MOSFET lifting speed governing electric controller
- New type low noisy gear pump

High performance guarantee high efficiency

- Lifting speed is increased by 10% and thus more goods can be lifted under the same conditions
- The truck has fast driving and lifting speed, higher working efficiency
- ZAPI Dual CPU controller conforming to the latest EU standard is equipped;
- The newly designed high-performance 80V voltage level motor has strong power;
- The latest ZAPI instrument can be equipped with height preset function. One key to reach the set height improves operation efficiency
- Small turning radius makes steering flexible and easy

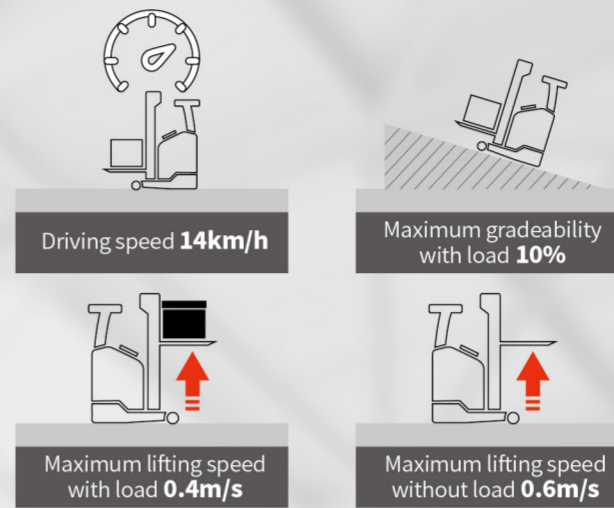

Advanced EPS electric powered steering

- EPS electric powered steering offering easy , flexible , high efficient and mute operation
- Steering motor controller
- Automatic centering function
- Real-time shifting between 180° steering mode and 360° steering mode
- Automatic limit on speed and accelerated speed when steering

Easy operated thumb switch

- To control hydraulic functions
- Clear operating units
- Proportional solenoid offering a stable and comfort lowering action

Environment Friendly

- Zero emission
- Low noise
- Free of heavy metals
- No corrosion
- No acid mist volatilization

Maintenance Free

- Unnecessary of fluid adding and dust proofing
- Daily maintenance free
- Manual maintenance free

Long Service Life

- Over 75% capacity reserved after 4000 shifts operation
- Longer service life than lead-acid battery in equal working condition
- 5 years or ten thousand hours quality guarantee for high performance lithium battery



High Efficiency and Energy Saving

- 1-2 hours charging meet 6-8 hours working demand
- High-energy density , self discharging rate lower than 1% per month
- 95% energy conversion rate , superior charging and discharging performance
- Flexible to charge , easy to operate , no impact on battery life
- Unnecessary to change battery , cost saving

High Safety

- According to the characteristics of industrial vehicles , it achieves safety protection design which includes lithium battery materials , battery core type , pack technique and system power management
- "Multiple node safety closed circuit protection" realizing truck real time closed circuit protection in variable conditions
- "Lock affirming" function during charging avoiding "hot connecting and disconnecting" operation effectively
- "Whole system emergency button" to disconnect the truck control system and bms power quickly ensuring truck safety

Suitable for working in both high and low environment

- Lithium battery low temperature automatic heating , low temperature adaptation performance is superior
- Lithium battery is better than lead-acid battery when working between -25°C and 55°C



Operating Cost Comparison:

Lithium battery forklift VS. Lead-acid battery forklift

Lithium battery forklift VS. Lead-acid battery forklift
The advantages of HELI lithium battery forklift trucks are more prominent in the cycle cost.

Lithium battery forklift truck has the advantages of no noise, no pollution, small vibration and simple operation

Compared with the lead-acid battery forklift truck, lithium battery forklift has the characteristics of fast charging and charging at any time, which is more suitable for multi shift operation.

Besides, HELI lithium battery forklift is maintenance free, high power conversion efficiency, and economical overall operation cost

